

User's Manual

*Digital Common Interface
Satellite Receiver
HSS-830HCI*



 HYUNDAI DIGITAL TECHNOLOGY



HYUNDAI DIGITAL TECHNOLOGY Co.,LTD.
Home Page : www.hdt.co.kr
E-mail : khchang@hdt.co.kr
reck@hdt.co.kr
yisang94@hdt.co.kr

HYUNDAI DIGITAL TECHNOLOGY EUROPE GmbH.
Home Page : www.hdte.de
E-mail : bksohn@hdte.de
spencer@hdte.de
info@hdte.de

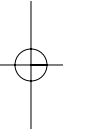
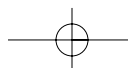

Contents

1. Introduction	2
1.1. Overview	
1.2. Main Features	
2. Safety/Precautions	3
2.1. Safety	
2.2. Precautions	
3. Check Point before Use	5
3.1. Accessories	
3.2. The Satellite dish	
4. Controls/Functions	6
4.1. Front Panel	
4.2. Rear Panel	
4.3. Remote Controller	
5. Using Remote Controller	12
5.1. Batteries	
5.2. Range Of Operation	
6. How to Connect	14
7. Operation	16
7.1. Getting Started	
7.2. Channel Editing	
7.3. System Parameters	
7.4. Transponder	
7.5. Factory Set	
7.6. Other Function on Remote Control	
8. Hard Disk Operation	66
8.1. Recording	
8.2. Playing	
8.3. Delete Programs	
8.4. Lock Programs	
8.5. Skip Play	
8.6. Split Operation	
8.7. Trick Play Controls without OSD	
9. Conditional Access	77
10. Trouble Shooting	79
11. Specifications	80

DiSEqC is a trademark of EUTELSAT.

Introduction

1

1.1 Overview

This Common Interface is your "Window to the World" giving you the opportunity to enjoy scrambled programs. Enjoy the rich choice of more than 4,000 different channels, broadcasting a large range of culture, sports, cinema, news, events, etc. This receiver is a technical masterpiece, assembled with the highest qualified electronic parts.

1.2 Main Features

- ▶ Fully compliant with MPEG-2 and DVB standards
- ▶ Integrated COMMON INTERFACE
- ▶ Multi-access with twin card reader for CI
- ▶ User friendly operating Menu and On-Screen Graphic Menu
- ▶ Easy to use EPG(Electronic Program Guide) on screen
- ▶ Age protection lock function
- ▶ Tele-text encoding
- ▶ Manual PID control
- ▶ Software downloading via RS-232C connector
- ▶ DiSEqC 1.2 compatible
- ▶ Hard Disk Functions

Safety/Precaution

2

2.1 Safety

Be sure to read the user's manual before starting the operation of the unit.

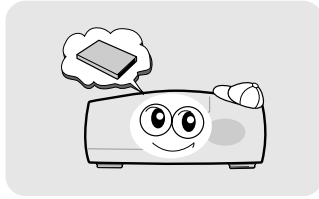

Do not touch the power cord with wet hands as it may cause electric shock.

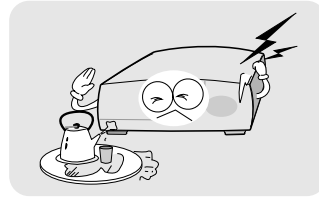

Never open the cover. It is very dangerous to touch the inside of the unit due to possible electric shock.

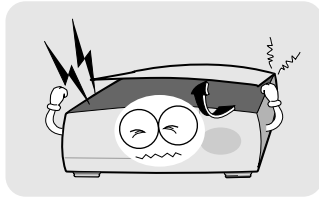

Place the unit in a well ventilated and no-heat environment.

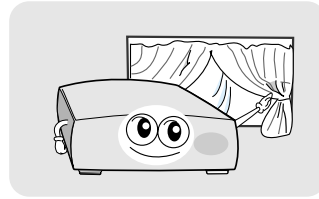

When you do not use this unit for a long time, make sure that power cord is pulled out from the outlet. Also do not use a damaged power cord as it may cause fire or electric shock.

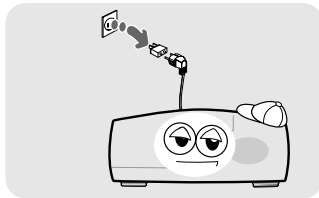

A professional installation is required. If reception is interrupted, contact your local service centre.

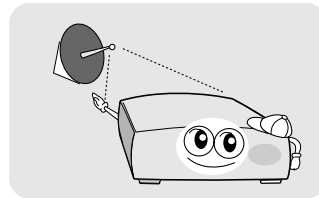

2.2 Precautions

When installing the unit

Install the unit horizontally. An uneven installation may cause the unit to be damaged.

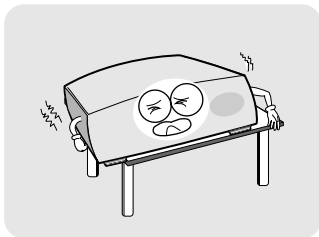

Do not put heavy items such as a TV on the unit. That may cause the unit to be damaged.

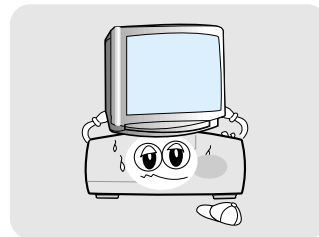

Do not install the unit:

- Where it is subject to vibrations
- Where it is exposed to direct sunlight
- Where there is humidity
- Where the temperature is too high or too low.
- Where there is no ventilation

Moving the unit to a hot area from a cold one will cause condensation. Do not operate the unit for one or two hours or until it has dried completely.

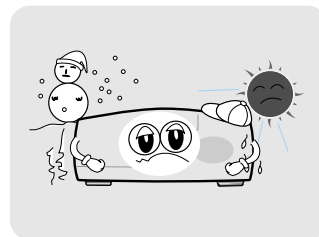
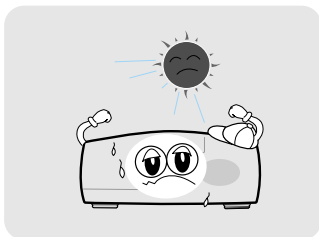

Check Points before Use

3

3.1 Accessories

Accessories of the Unit

User's manual : 1

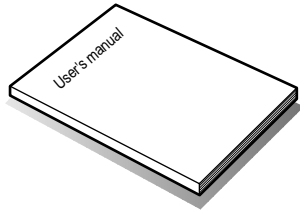

Remote control : 1



Batteries (AAA type) : 2

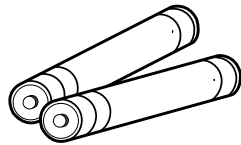

▶ If any accessories listed above are missing, contact the sales representative where you purchased this unit.

3.2 The Satellite dish

Your dish should be properly installed and azimuth and elevation must be precisely set up.

▶ This unit is working with DiSEqC 1.2 on a compatible antenna positioner. Ask your dealer for information.

Controls/Functions

4

4.1 Front Panel

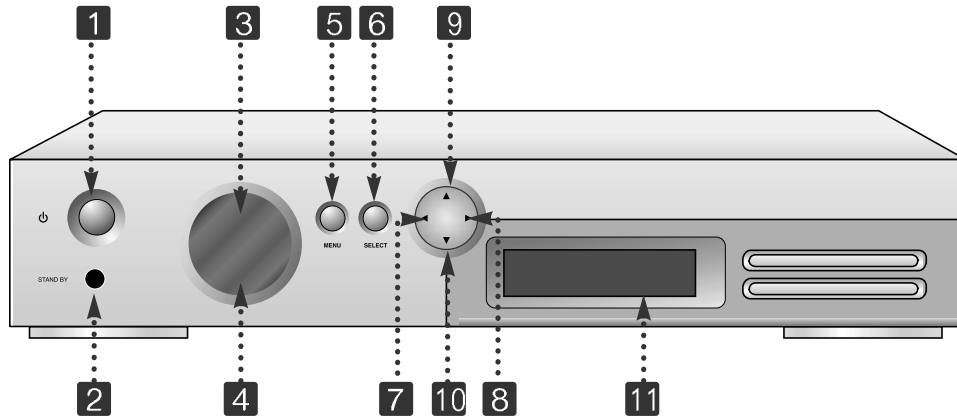

1 Power

To switch the receiver in "standby" mode or in power on mode.

2 Standby/Power on Indication light

Flashing red in "standby" and no light in power on mode.

3 Remote Sensor

Receives the infrared signal from remote control.

4 Channel Display(4 Digit)

- When you connect the power line of the receiver, the current time is displayed.
- After programming, the program number or name is displayed.

5 Menu

To launch or terminate the menu application.

6 Select

To activate a highlighted item or go to next level on hypertext menu or confirm the user's action.

4.1 Front Panel

7 - 8 Vol. (◀/▶)

To adjust the volume level or change the value of an item with preprogrammed values. The Key **Vol.◀** can be used as a backspace to cancel the numerical input.

9 - 10 CH. (▲/▼)

To change channel or cursor position on the application screen.

11 Slot A, B

PCMCIA-module : provided by a broadcaster for watching scrambled programs.

4.2 Rear Panel

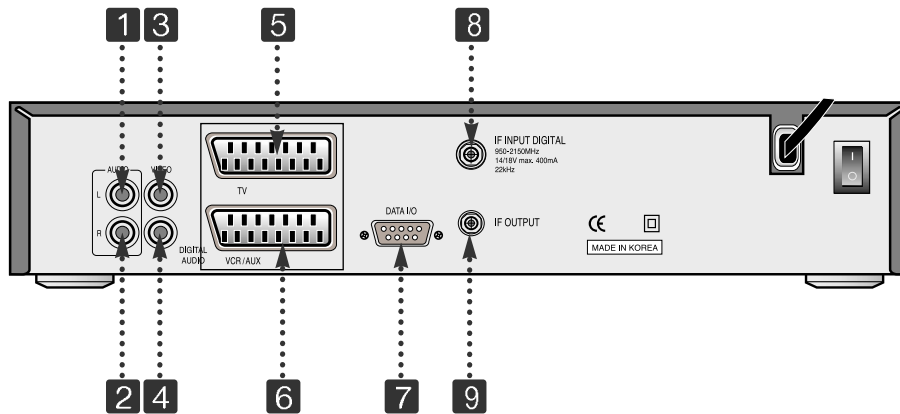

No.	Name	Connector	Function
1.	AUDIO L	RCA cinch	Left audio output.
2.	AUDIO R	RCA cinch	Right audio output.
3.	VIDEO	RCA cinch	Composite video output.
4.	Digital Audio	RCA cinch	Digital Audio Output
5.	TV SCART	SCART	SCART output to TV.
6.	VCR/AUX SCART	SCART	SCART output to VCR, analog receiver or Hi-Fi.
7.	RS-232C	DB-9	Low speed serial port.
8.	LNB INPUT	IEC 169-24 female	IF input from LNB to digital tuner.
9.	LOOP OUT	IEC 169-24 female	IF loop-through output from digital tuner.

4.3 Remote Control

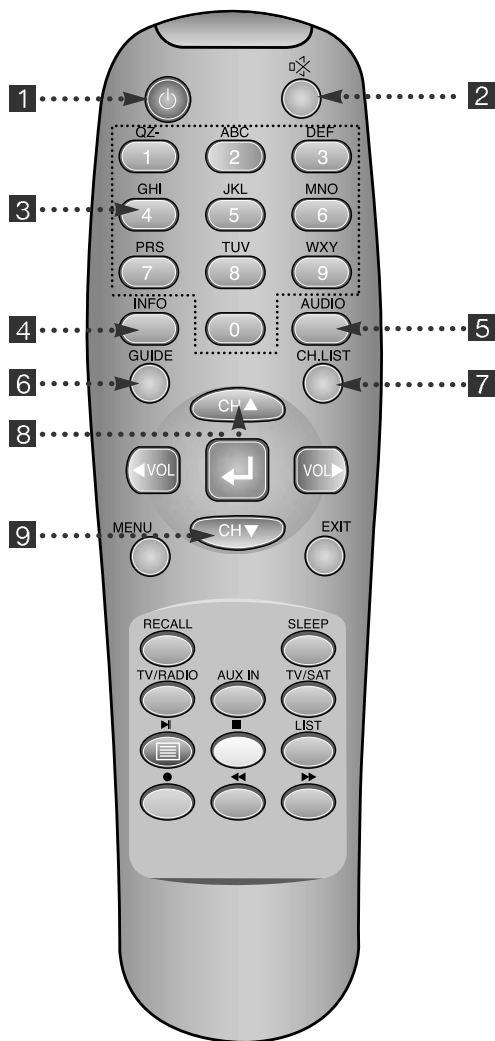

- 1 POWER :**
To switch into 'standby' or 'power on' mode.
- 2 MUTE :**
To turn the sound on/off.
- 3 Numeric Keys(0-9) :**
To select channels and input of channel numbers or characters.
- 4 INFO. :**
To display the information of the current channel.
- 5 AUDIO :**
To change the audio track, stereo-mono mode.
- 6 GUIDE :**
(EPG : Electronic Program Guide)
To watch program information. Press once more to return to normal mode.
- 7 CH LIST :**
To watch the channel list.
Press to confirm or press EXIT to return to previous chosen channel.
- 8 - 9 Up & Down :**
To change the value of a selected item with preprogrammed values in menu.

4.3 Remote Control

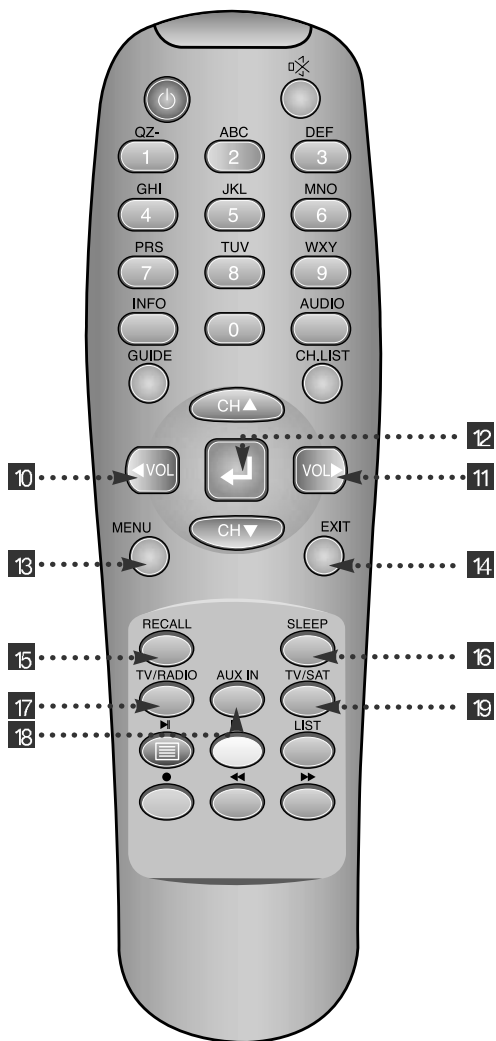

10 - 11 Left & Right :

To move the cursor up and down in menu.

can be used as a backspace to cancel the numerical input.

12 (ENTER) :

To select an item or to confirm a menu.
Pause function.

13 MENU :

To enter/exit the main menu.

14 EXIT :

To return to previous status or menu.

15 RECALL :

To return to the previous chosen channel.

16 SLEEP :

To switch off the receiver automatically after between 30 and 150 minutes.

17 TV/RADIO :

To switch between the TV and radio channels.

18 AUX IN :

To select the output mode of scart connector.

19 TV/SAT :

To toggle the TV output source between the satellite input and UHF/VHF antenna input. If your receiver has no 'TV ANT IN' terminal in the rear panel, this key may not work.

4.3 Remote Control

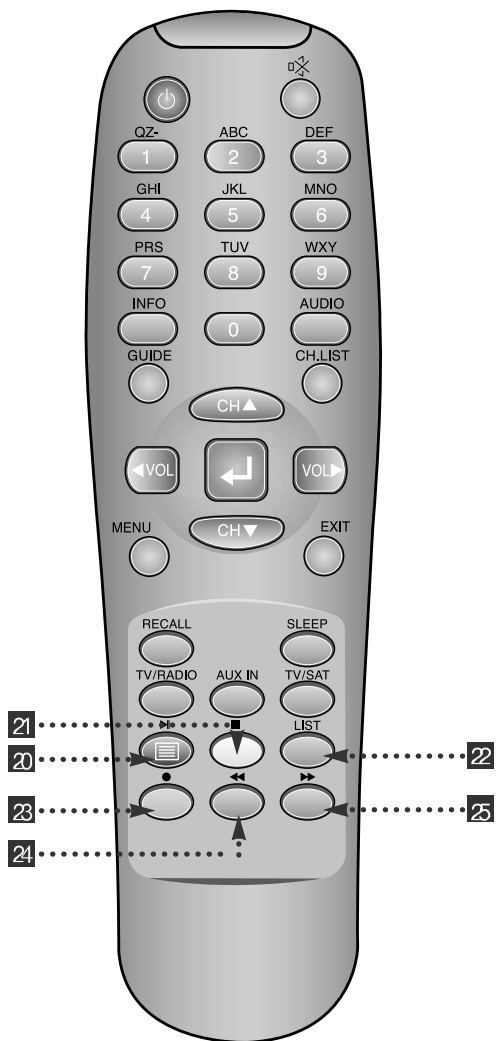

20 BLUE ►| :

To delete a channel from the Channel List menu. To show extended program information in the EPG menu. To see Teletext Service Data. To play or pause the stored programs on HD.

21 IVORY ■ :

To add a new channel to the Channel List menu. To stop the played programs on HD.

22 ORANGE (LIST) :

To see variant channel lists for user's convenience in the Channel List menu. To watch the list of stored programs on HD.

23 RED ● :

To setup favorite channel lists in the Channel List menu. To record the program on to HD. To delete the stored programs on HD or set skip points.

24 GREEN ◀◀ :

To lock channel in the Channel List menu. To show current/next program information in the EPG menu. To play the stored programs on HD with fast forward mode.

25 YELLOW ▶▶ :

To move a channel to other position in the Channel List menu. To show program schedule information in the EPG menu. To play the stored programs on HD with fast reverse mode.

Using the Remote Control

5

5.1 Batteries

- ▶ **How to insert a battery**
 - ❶ Open the cover at the top of the rear side of the remote control.
 - ❷ Insert two AAA type batteries(1.5V) to be aligned with appropriate +/- polarity.
 - ❸ Close the cover completely.
- ▶ **When to replace a battery**

If the operational range of remote control is getting smaller, it indicates batteries are almost consumed.
Replace both batteries together.
- ▶ **How to replace a battery**
 - ❶ Check +/- polarities and insert batteries to be aligned with appropriate +/- polarity.
 - ❷ Even if old and new batteries are the same in size, do not use batteries with different characteristics.
- ▶ **Accident prevention**
 - ❶ Do not recharge, heat or disassemble the battery. Do not cross +/- polarities.
 - ❷ If remote controller is not going to be used for a long time, take the batteries out.

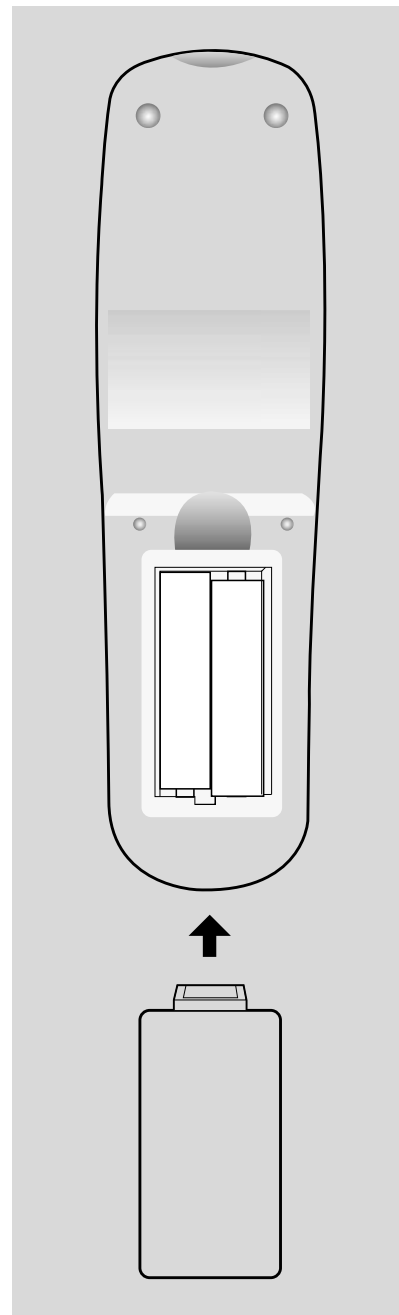

5.2 Range of Operation

- ① The remote controller can be detected by the receiver within an angle of 30 degrees to the left or right.
- ② The transmission distance of the remote control is 7m in direct line of sight.

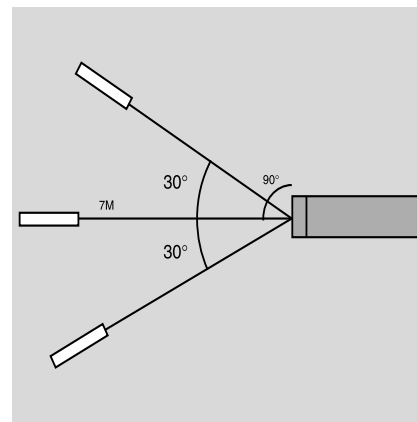
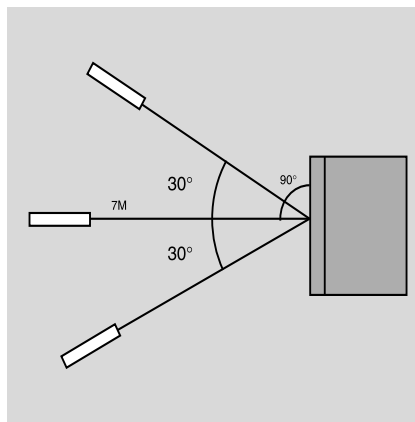

* Notes

- ① **When the remote control is not operative**
Replace batteries with new ones and check AC power plug on the receiver.
- ② **Abnormal operation**
Disturbance from peripheral devices might occur. Ensure that other products which might cause interference are placed further away from the receiver.
- ③ **Notes for handling**
If exposed to heat or water, the main body and the remote control may be damaged, so be careful.

How to Connect

6

6.1 Connecting IRD to TV with AV connectors

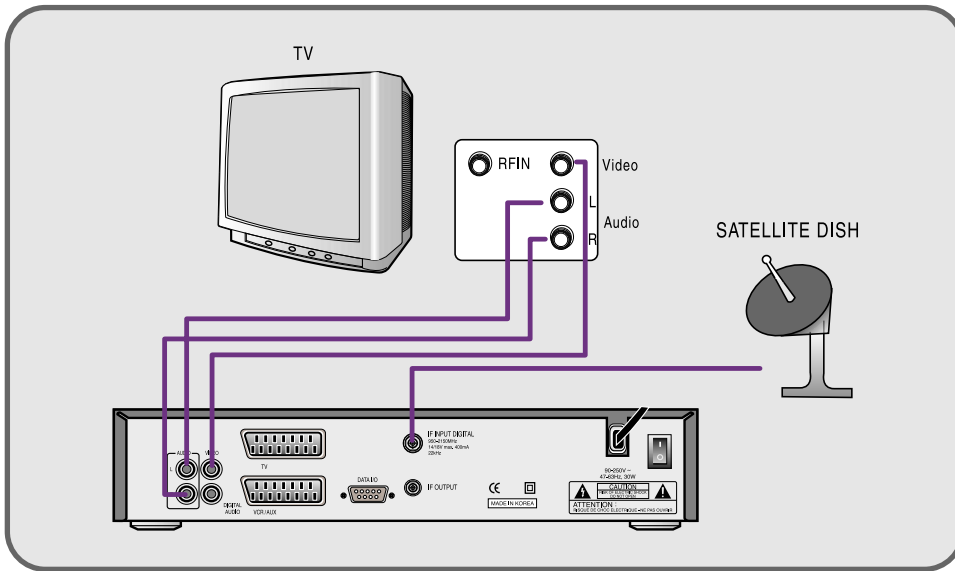

6.2 Connecting IRD to TV with SCART

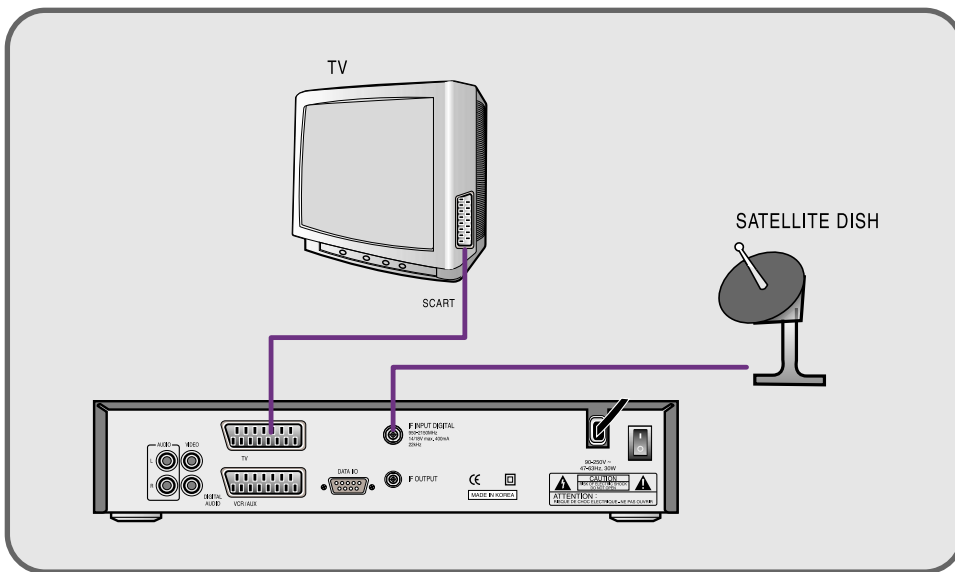

6.3 Connecting IRD to Hi-Fi system and TV with SCART

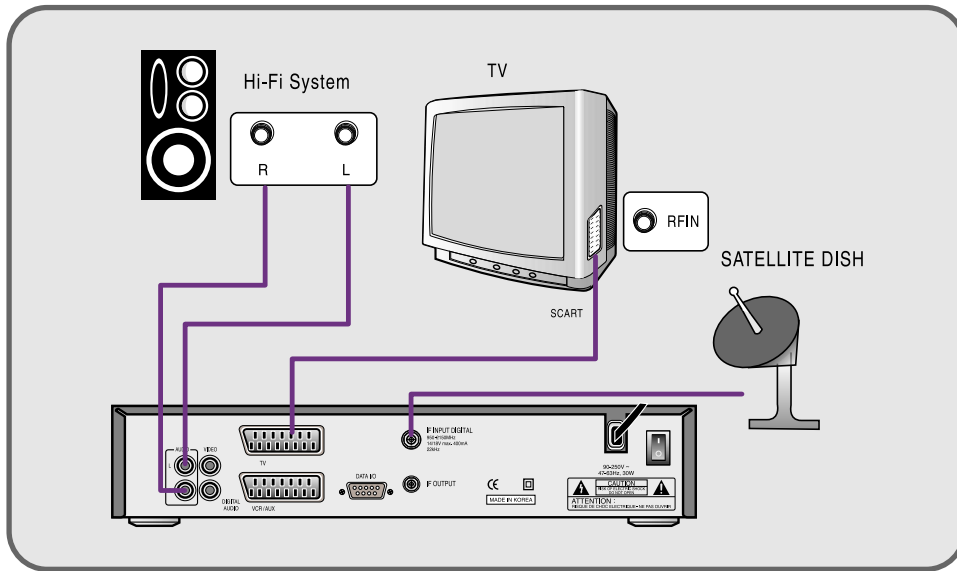

6.4 Connecting IRD to VCR and TV

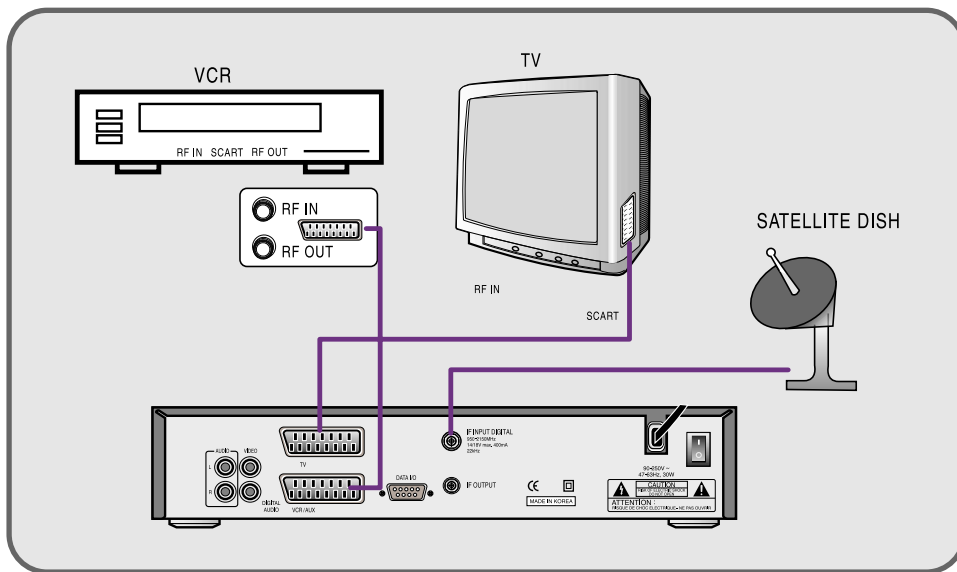

Operation

7

7.1 Getting Started

After your receiver is powered up, proceed with installation as follows:

1 Menu Language Setting

- ① When you plug in AC power, the following will be displayed on the front.

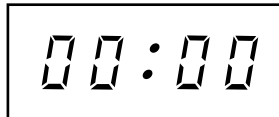

- ② Press **POWER** on remote, the LED number will be displayed as follows:



- ③ Press **MENU** key and position cursor on 'Language' column with **CH+** or **CH-**.

- ④ Select language you want with **VOL+** or **VOL-**.

Screen

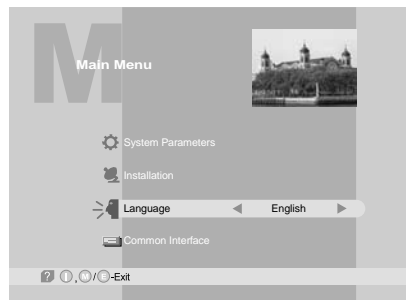

** Note : Languages displayed in 'Language' column are supported by your receiver.*

7

7.1 Getting Started

2 Help

If you want to know how to use current part in the menu, use 'help' function.

- ① Select a content in the menu.

For example, if you want to know about the installation menu, select installation.

Screen

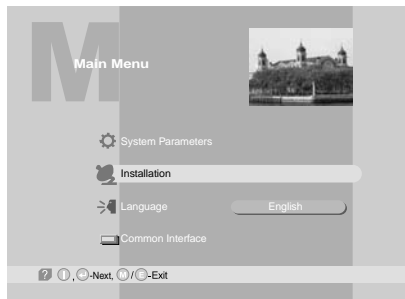

- ② Press INFO. Then you can see the help window of the selected content.

Screen

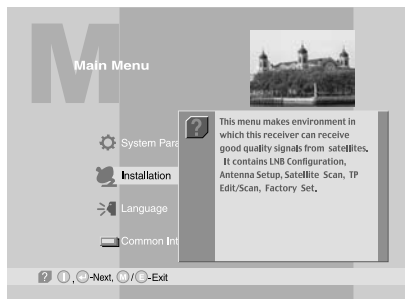

3 Satellite Setting

Since your receiver has the basic data of most satellites and channels, you can receive programs just by plugging in. But, according to the status of your antenna setup, you may have to modify the basic data of satellites and / or channels.

When you need to modify the data, proceed as follows ;

7

7.1 Getting Started

- 1 Press **MENU** key and position the cursor on Installation column with **CH▲** or **CH▼** and press **↵**.

Screen

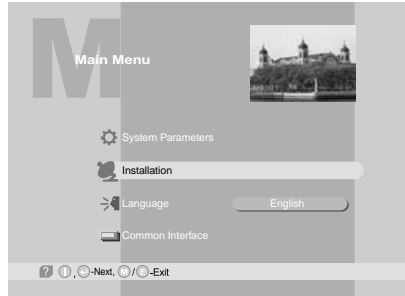

- 2 By using **CH▲** or **CH▼**, select 'LNB Configuration' and press **↵**.

Screen



*** Note : Enter 4-Digit password if need arise.
The default password is '0000'**

- 3 Select the **Satellite** you want to add with **CH▲** or **CH▼** and press **←VOL** or **→VOL**.

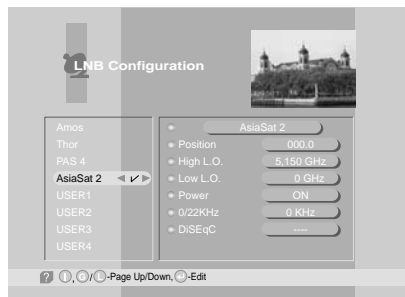

Screen



7.1 Getting Started

④ If you press , the selected **Satellite** will be added and the cursor will move to right window for detailed installation.



** Note : If you just want to edit the data of the satellite which is already contained in the receiver, press  after you select the satellite.*

⑤ Select item you want to edit with  or  and change each parameter.

- Position : You can input the longitude of the satellite with numeric keys.

- High L.O. / Low L.O. : Enter LNB oscillator frequency with numeric keys.

- Power : Set LNB power ON or OFF with  or .

- 0/22KHz : Set the path of 0/22KHz switch box with  or .

- DiseqC : Set the path of DiSEqC box with  or .

If you do not use the switch box, set as " - - - " .

** Note : When you change each parameter, you need to know exact parameter of LNB to modify L.O.(local oscillator) frequency.*

** Note : When you change each parameter, you need to understand environment of connecting the receiver and antenna in order for you to set 22KHz and DiSEqC properly.*

⑥ When necessary, you can change a **satellite name** as you wish.

You can enter alphabetic characters with the numeric keys.

For example, if you want to enter 'SAT-1',

Press                 .

** Note : Press   for space.*

⑦ After the installation procedure, press **EXIT** key or **MENU** key to store your entered data.

7

7.1 Getting Started

4 Antenna Setup

You need to position your antenna correctly for reception of the best signal.

- 1 Press **MENU** key.
- 2 Select 'Installation' with **CH▲** or **CH▼**, and press **Enter**.

Screen

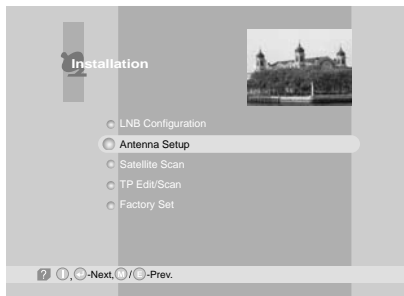

- 3 Select 'Antenna Setup' with **CH▲** or **CH▼** and press **Enter**.

Screen

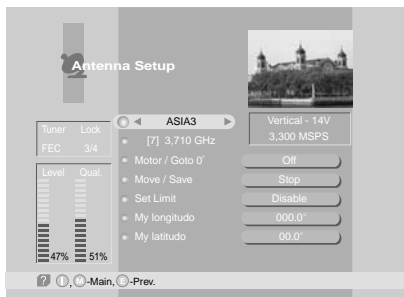

Level	Indicating selected satellite signal strength level
Quality	Indicating signal to noise ratio

7.1 Getting Started

- ④ Select the **satellite** you want with or .
- ⑤ Press to move to TP section and select the TP you want with or .
- ⑥ When the satellite and the TP are selected, you can check the reception status of the satellite signal. If the reception signal status is bad, adjust antenna to get the following result.

Tuner	Lock
FEC	1/2, 2/3, 3/4, 5/6 or 7/8
Level	over 30%
Quality	over 10%

⑦ DiSEqC 1.2 Positioner Setting

- Motor / Goto 0

Determine the kind of Motor & whether or not controlling it by using or .

On	Using DiSEqC Motor.
Off	Not using DiSEqC Motor.
STAB	Using the specific Motor supplied by Stab company. Determine the longitude of the satellite on LNB Configuration Menu. If the longitude of the satellite on LNB Configuration Menu is setted, user must input the longitude about your position at present

If you press , DiSEqC Motor will move toward Zero Equator.

- Move / Save

Motor moves to West & East direction.

- Set Limit

Determine the value of Limit of Motor.

If you select , the value of Limit will be changed.

- My longitude / My latitude

You can use this item when STAB is setted on 'Motor/Goto 0'.

Determine your longitude & latitude at present.

'East/West' is changed by using or .

7.1 Getting Started

5 Satellite Scan

After finishing 'Antenna Setup', execute a 'Satellite Scan'. Then you can get all channels in the pre-programmed TPs. This function can also be used to get the latest channel data while receiver is in use. Through this function, the receiver searches for all the available channels and saves them in the memory.

- ① Press **MENU** key.
- ② Select 'Installation' with **CH▲** or **CH▼**, and press **↵**.
- ③ Select 'Satellite Scan' with **CH▲** or **CH▼**, and press **↵**.

Screen



- ④ Select 'Scan Mode' with **CH▲** or **CH▼**.
- ⑤ Select the scan mode you want with **◀VOL** or **VOL▶**.
- ⑥ Select the satellite name you want with **◀VOL** or **VOL▶**.

Screen

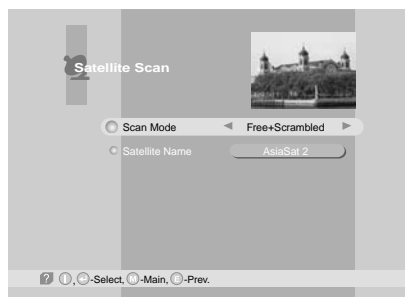

7

7.1 Getting Started

7 If you press , the selected satellites will be scanned.

Screen

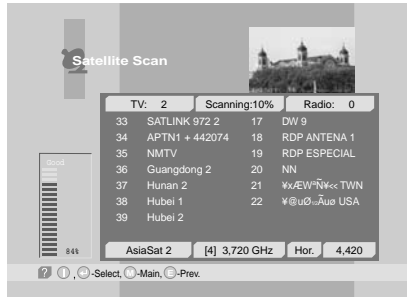

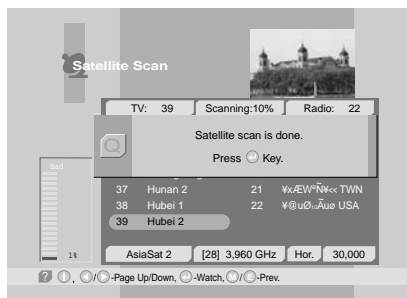

8 While scanning, you can see the following menu on the screen.

Screen



9 After the scanning process, the first channel of the last scanned TP will be displayed on the back screen.

10 Press  to finish the process. Then select a channel and press  to watch a program or press **MENU** key or **EXIT** key.

*** Note :** Now you have completed all steps needed for watching programs. If you could not see the program after finishing these procedures, please contact your engineer or representative.

7.1 Getting Started

6 Select Channel

You can change the current channel to any other channel you want.

- ▶ If you do not know the channel name, or you want to select a channel at random, you can navigate between channels with **CH▲** or **CH▼** (**CH. Up/Down**) till you find the channel you want.
- ▶ If you know the channel number, enter the number and wait 5 seconds for the channel to change.
- ▶ If you know the channel name, press **CH LIST** key then channel list will pop-up.

Screen

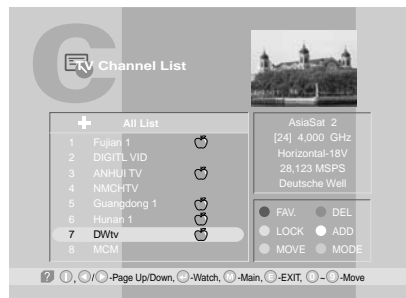

- ① In the right section, detailed information of the selected channel will be displayed. (Name of satellite, frequency, symbol rate, etc.)
- ② Select the channel you want with **CH▲** / **CH▼** (scroll up/down) or **VOL▲** / **VOL▼** (page up/down).
- ③ When the scroll bar is positioned on the channel you want to see, press **ENTER**.

7

7.1 Getting Started

7 Volume Control

- ① While you are watching a program, press  or .

Screen



- ② When necessary, press **MUTE** key to remove the sound of the program temporarily.

Then, your receiver goes into mute condition and the volume bar will become red. Press **MUTE** key again to turn the sound on.



7.2 Channel Editing

1 Favorite Channel

You can set up favorite channel lists as you want.
 For example, if you want to set favorite channel lists as following.

- Favorite1 : 7 DWtv, 6 Hunan1
 - Favorite2 : 1 Fujian1
 - Favorite3 : 3 ANHUI TV, 5 Guangdong1
- Firstly, set favorite1 channels.

- 1 Press CH.LIST.
- 2 Select 'DWtv' channel with / or / .

Screen



- 3 Press RED.

Screen

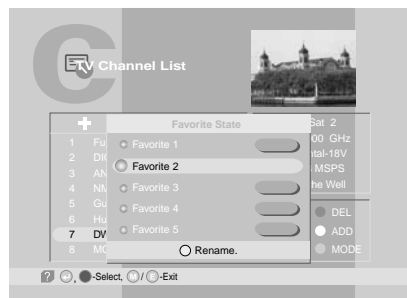



7.2 Channel Editing

4 Select favorite1 with / and Press .

Screen



Do the same for the 'Hunan 1' channel.

Screen



7

7.2 Channel Editing

6 Press RED.

Screen



6 Press [Left Arrow].

Screen



Favorite1 ~ Favorite5 are default name. Users can rename them for their convenience. If you want to rename 'Favorite1' (for example 'Drama').

7 Press RED.

Screen





7.2 Channel Editing

③ Select 'Favorite 1' with / .

Screen



④ Press **IVORY**.

Screen



TV/SAT LED	Power ON	Power OFF
ON	TV ANT IN signal will be out.	
OFF	Decoded signal will be out through RF.	TV ANT IN signal will be out.



7.2 Channel Editing

- ⑩ 3 3 VOL+ 7 7 7 VOL+ 2 2 VOL+ 6 6 VOL+ 2 2 VOL+ 0 0 VOL+ 0 0
- VOL+ 0 0 VOL+ 0 0 VOL+ 0 0

Screen



- ⑪ Press **MENU**, **EXIT** or to finish the process.

You have finished favorite1 channel setting.

With similar way, you can set favorite2 ~ favorite5 channel list.

You can use these favorite channel lists by using **ORANGE** key.

Refer to the next section for detail.



7.2 Channel Editing

2 Channel List Mode

Using this function, you can see variant channel lists which may enable you to edit and select channels more conveniently.

Favorite Mode

If you have set up favorite channel lists as the previous section, you can use them as following.

- 1 Press CH.LIST.

Screen



- 2 Press ORANGE.

Screen

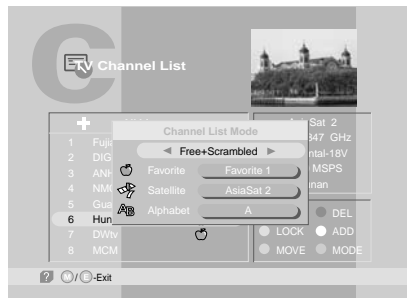

7

7.2 Channel Editing

- ③ You can see 'Channel List Mode' window. Select 'Favorite' with **CH▲** / **CH▼** and select 'Favorite1' with **VOL◀** or **VOL▶**.

Screen



- ④ Press **↓**.

Screen

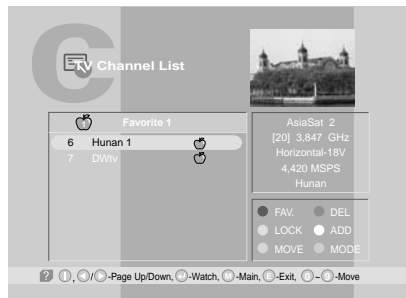

- ⑤ You can see only favorite1 channels are listed. With similar way, you can see favorite2 ~ favorite5 channel list.
- ⑥ If you want to return to all channel list (all channels of the selected satellite), press **ORANGE** and select 'Satellite' with **CH▲** / **CH▼** and press **↓**.

Screen

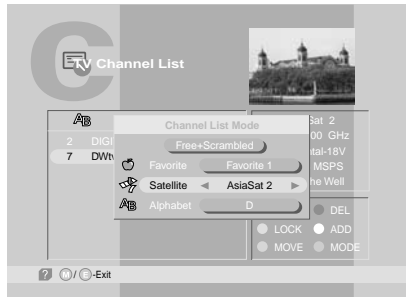

7

7.2 Channel Editing

Alphabet Mode

Using this function, you can see the channel list which have same initial. This function is useful when you search specific channel among the list of thousands channels. For example, if you want to see the channel lists which start with 'D'.

- 1 Press **ORANGE** in the channel list and select '**Alphabet**' with **CH▲** / **CH▼**.

Screen

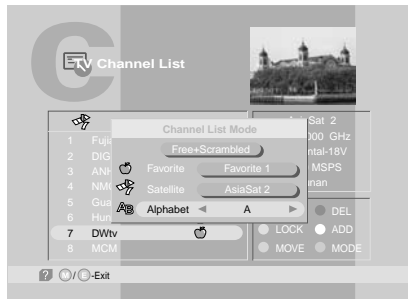

- 2 Select '**D**' with **◀VOL** / **VOL▶**.

Screen



- 3 Press **◀**.

Screen

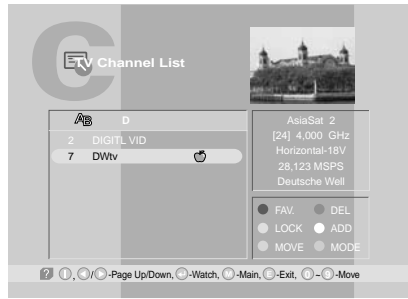

- 4 You can see the channel list where all channels have initial '**D**'.



7.2 Channel Editing

Free only Mode

- 1 Press **ORANGE** in the channel list and select first line with **CH▲** / **CH▼**.
Select 'Free only' with **◀VOL** / **VOL▶**.

Screen

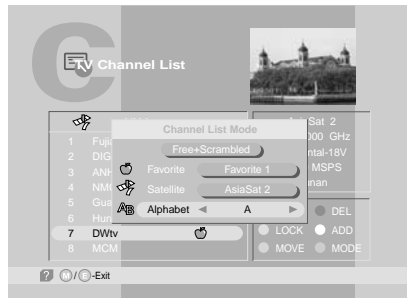

- 2 Select 'Favorite' or 'Satellite' or 'Alphabet' and press **◀**. You can see only the selected 'free' channel list.

Free + Scrambled Mode

- 1 Press **ORANGE** in the channel list and select first line with **CH▲** / **CH▼**.
Select 'Free+ Scrambled' with **◀VOL** / **VOL▶**.

Screen





7.2 Channel Editing

2 Select 'Favorite' or 'Satellite' or 'Alphabet' and press . You can see the selected free and scrambled channel list.

Screen



* Note : 'Scrambled' channel can be shown only with CI (Common Interface) model and CAS (Conditional Access System) model.
 'Free' channel can be shown with all (FTA(Free To Air) and CI and CAS) model.

Satellite Mode

By using this function, you can see all channel list of the selected satellite.

1 Press **ORANGE** and select 'Satellite' item with / .

Screen

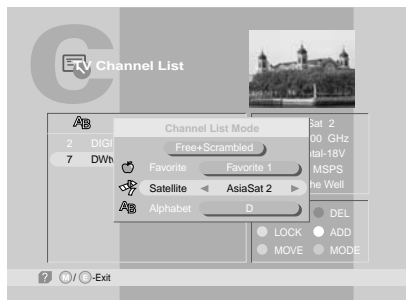

2 Press / to select a satellite and press .



7.2 Channel Editing

3 Lock Channel

This menu enables you to prevent children from viewing programs unsuitable for their age.

- 1 Press **CH.LIST** and Select the channel you want to lock with **CH▲** / **CH▼** or **VOL▲** or **VOL▼** and press **GREEN**.

Then the selected channel is locked.

Screen



** Note : If 'password' window is risen as following picture, enter password with numeric keys (default password is '0000'). Then you can lock the channel. If you don't want this window, change 'Parental Control' set up in the 'System Parameters' menu. Refer to the 'Parental control' in 'System parameters' in this manual for detail.*

Screen





7.2 Channel Editing

Screen



- ② Press **MENU**, **EXIT** or to finish the process.
- ③ Without entering your password, you cannot watch a locked channel's program.

Screen



- ④ If you want to cancel the channel lock, go to the channel list and select the channel and press **GREEN**.



7.2 Channel Editing

4 Channel Order Setting

You can organize the number or sequence of the channels.

- 1 Press CH.LIST.

Screen



- 2 Select the channel you want to move with / or / and press YELLOW.

Screen

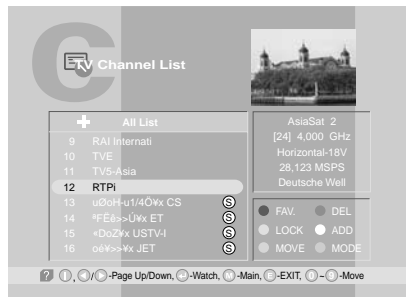

- 3 Move the selected channel with / or / to the position you want.

Screen

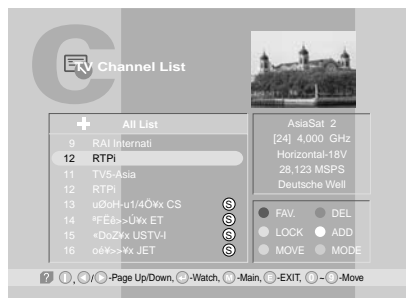



7.2 Channel Editing

4 Press **YELLOW**.

Screen



5 Press **MENU**, **EXIT** or **[Left Arrow]** to finish the process.

5 Delete Channel

You can delete channels from the channel list.

1 Press **CH.LIST** and select the channel you want to remove with **[CH+]** / **[CH-]** or **[VOL-]** / **[VOL+]**.

Screen





7.2 Channel Editing

2 Press **BLUE**.

* *Note* : If 'password' window is risen as following picture, enter password with numeric keys (default password is '0000'). Then you can delete the channel. If you don't want this window, change 'Parental Control' set up in the 'System Parameters' menu. Refer to the 'Parental control' in System parameters' in this manual for detail.

Screen

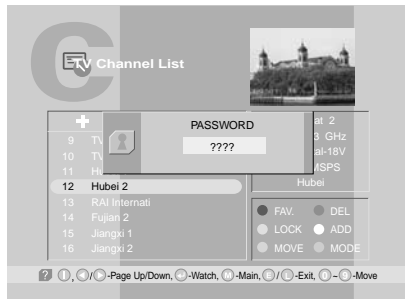

3 Then, you need to confirm the deletion. If you definitely want to delete, press . If not, press **EXIT**.

Screen



* *Note*: Please be careful when you delete channel(s).

4 Press **MENU**, **EXIT** or to finish the process.



7.2 Channel Editing

6 Add Channel

1 Press CH.LIST.

Screen



2 Press Ivory.

Screen

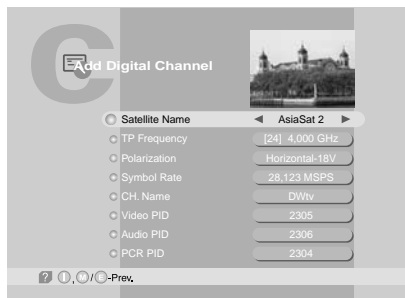

3 Select a satellite into which you want to add your new channel.

* **Note** : You can only select satellites which you set in 'Installation' menu.

4 Move to 'TP Frequency' section (column) by pressing **CH** and change frequency with **VOL** / **VOL** or enter frequency with numeric keys.

* **Note** : TP frequency consists of 5 digits ending with GHz.

* **For example** : TP Frequency 4.000GHz is **0** **4** **0** **0** **0**

7.2 Channel Editing

- ⑤ Move to 'Polarization' by pressing  and select Horizontal or Vertical with  or .



* **Note** : Please check whether LNB Power is ON in 'Installation' menu

- ⑥ Move to 'Symbol Rate' by pressing  and enter the Symbol Rate value with numeric keys.

- ⑦ Move to 'CH. Name' by pressing  and enter the alphabetic characters with numeric keys.

* **For example** : if you want to enter SAT-1,

* **Note** : Press   for space

- ⑧ Move to 'VIDEO PID' by pressing  key and enter the proper value with numeric keys.

- ⑨ Move to 'AUDIO PID' by pressing  key and enter the proper value with numeric keys.

- ⑩ Move to 'PCR PID' by pressing  key and enter the value between 0000~8192 with numeric keys.

* **Note** : The above mentioned TP Frequency, Symbol Rate, VIDEO PID, AUDIO PID, PCR PID are very important for optimal satellite signal reception. We recommend you get professional advice where available. You cannot setup 'VIDEO PID' for RADIO channels.



7.3 System Parameters

1 Setting Age Restrictions

This sub-menu allows you to set the age for parental locking and protect children from viewing programs unsuitable for their age.

- 1 Press **MENU** key.
- 2 Press **CH1** or **CH2** to select 'System Parameters' and press **Enter**.

Screen

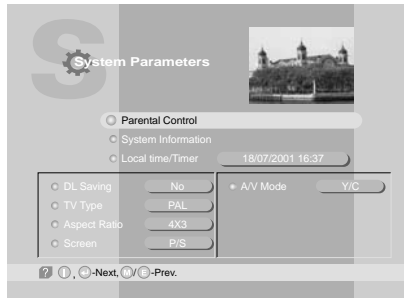

- 3 Press **CH1** or **CH2** to select 'Parental Control' and press **Enter**.

Screen

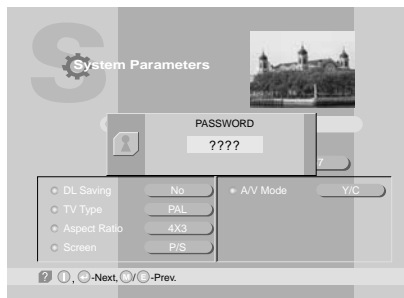

7

7.3 System Parameters

④ Enter 4-digit password.

* Note : The default password is '0000'

Screen

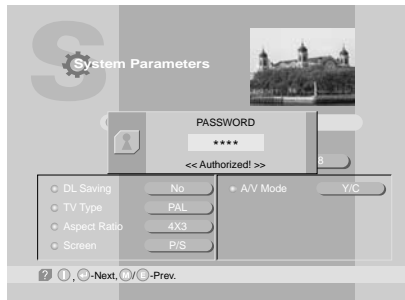

⑤ Press **CH+** or **CH-** to select 'Age Limit'.

Screen

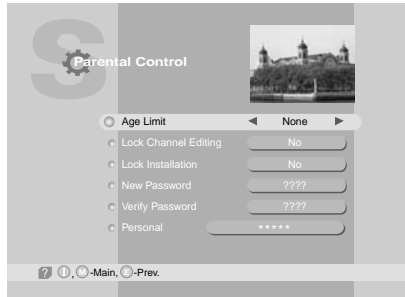

⑥ Press **VOL-** or **VOL+** to select age you want.

None	No age limit
8	Without entering password, programs are restricted to those who are over 8 years old.
12	over 12 years old.
15	over 15 years old.
18	over 18 years old.

* Note : 'Age limit' can be applicable only for the signal which carries age limit information.

7.3 System Parameters

2 Security Check

You can set **SECURITY CHECK** to protect your current installation from being changed (location shift, deletion, adding etc.) or modifying of installed data.

- ① Press **MENU** key
- ② Press **CH1** or **CH2** to select '**System Parameters**' and press **↓**.
- ③ Press **CH1** or **CH2** to select '**Parental Control**' and press **↓**.
- ④ Enter 4-digit password.

*** Note : The default password is '0000'**

- ⑤ Press **CH1** or **CH2** to select '**Lock channel Editing**', or '**Lock Installation**'.
- ⑥ Press **VOL+** or **VOL-** to select '**Yes**', or '**No**'.

Yes	When you process with ' Channel Editing ' or ' Installation ' of Main Menu, your receiver will ask for password. If you enter wrong password, you cannot proceed further.
No	You do not enter password during your processing.

*** Note : Your receiver is pre-set as 'No'.**

3 Password Changing

You can change your password.

- ① Press **MENU** key.
- ② Press **CH1** or **CH2** to select '**System Parameters**' and press **↓**.
- ③ Press **CH1** or **CH2** to select '**Parental Control**' and press **↓**.
- ④ Enter 4-digit password.

*** Note : The default password is '0000'**

- ⑤ Press **CH1** or **CH2** to select '**New Password**'.



7.3 System Parameters

- ⑥ Press 0 ~ 9 numeric numbers to enter new password.
- ⑦ Press 0 ~ 9 numeric numbers again to verify the new password.

** Note : When you forget your new password, please consult the shop where you bought the receiver or the nearest dealer.*

4 Personal Information Setting

You can enter your personal information, such as your name and address, etc.

- ① Press MENU key.
- ② Press CHA or CHY to select 'System Parameters' and press .
- ③ Press CHA or CHY to select 'Parental Control' and press .
- ④ Enter 4-digit password.

** Note : The default password is '0000'*

- ⑤ Press CHA or CHY to select 'Personal'.
- ⑥ Press 0 ~ 9 numeric numbers to enter new personal information.

** For example: If you want to enter 'WELCOME',*

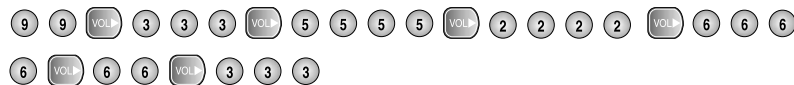

- * Note : 1. Maximum 32 letters can be entered.*
- 2. Your entered personal information will be displayed on the TV screen as Welcome Window when you power on your receiver.*
- 3. Initial information is ' * * * * * '.*
- 4. After purchasing the receiver, if information other than that which you entered is displayed, please consult the shop where you bought it.*
- 5. Personal Information does not affect your viewing in any way.*



7.3 System Parameters

5 System Information

You can check the current information about your receiver such as receiver's software and hardware version or manufacturing date.

- 1 Press **MENU** key.
- 2 Press **CH+** or **CH-** to select 'System Parameters' and press **↓**.

Screen

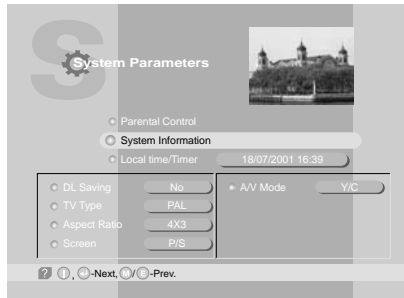

- 3 Press **CH+** or **CH-** to select 'System Information' and press **↓**.

Screen

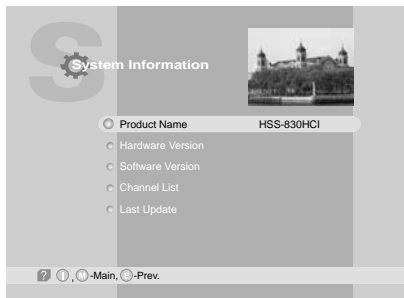

*** Note :** This information is necessary when you download new software or you need to repair the receiver.



7.3 System Parameters

6 Setting Timer (Automatic power On/Off)

You can pre-set the on/off time of your receiver.
 During your absence, you can record programs on your VCR.

- 1 Press MENU key.
- 2 Press **CH+/-** or **CH V** to select 'System Parameters', and press **ENTER**.

Screen

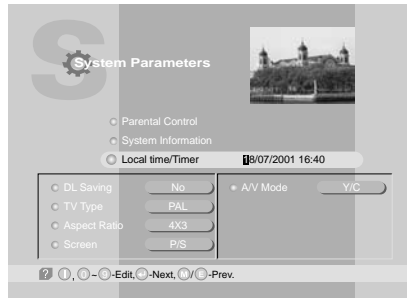

- 3 Press **CH+/-** or **CH V** to select 'Local Time/Timer', and press **ENTER**.

* Note : Without the local time setting, this 'TIMER' function does not work.

Screen

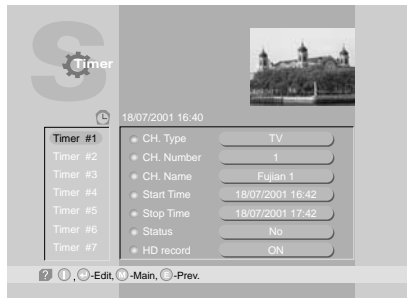

- 4 Press **CH+/-** or **CH V** to select 'Timer #(number)' you want to set and press **ENTER**.
- 5 determine 'CH. Type' by selecting 'TV' or 'RADIO' with **VOL-/+** or **VOL+/-**.

7

7.3 System Parameters

- 6 Select 'CH. Number' with or and enter channel number with numeric keys or with or .
- 7 Select 'Start Time' for your receiver power-on.
 - * For example : For 1st of February in the year of 2000, 7:30 P.M.,
Enter in sequence
- 8 Select 'Stop Time' by pressing .
- 9 Enter power off time in the same way as you entered 'Start Time'
- 10 Select 'Status' and set 'Once/Daily/Weekly/No' with or .
- 11 Select 'HD record' and set 'ON' with or if you want to record automatically.
 - * Note : 1. Without 'STATUS' being actuated (ON), Timer does not work.
 - 2. If Prior time than current is entered, Timer does not work.
 - 3. You can pre-set 14 TIMERS simultaneously. Regardless of number of TIMER, Timer will work in sequence of time sequence.
 - 4. Remocon Key doesn't work while VCR recording. (While HDD recording, remocon key works)

7 Setting Day Light Saving Time (Summer Time)

You can adjust current local time when summer time is applicable.

- 1 Press MENU key.
- 2 Press or to select 'System Parameters', and press .
- 3 Press or to select 'DL Saving'.
- 4 Press or to select 'Yes' or 'No' .







Yes	Set for daylight saving function activated The current time automatically moves one hour ahead
No	Set for daylight saving function deactivated The current time automatically moves on hour behind

* Note : Without current local time setting, this menu cannot be processed.

7.3 System Parameters

8 Setting TV Type

You can set your TV display mode with this sub-menu.

- ① Press **MENU** key.
- ② Press  or  to select 'System Parameters', and press .
- ③ Press  or  to select 'TV Type'.
- ④ Press  or  to select 'Multi', 'PAL', or 'NTSC'.







Multi	When your TV is compatible with NTSC/PAL dual mode.
PAL	When your TV is only for PAL reception. Regardless of satellite signal, the display will be done in PAL format.
NTSC	When your TV is only for NTSC reception. Regardless of satellite signal, the display will be done in NTSC format.

*** Note :** *If the satellite signal and your TV type are mismatched, the TV picture may be distorted. Even in this case, MENU will be displayed as normal. (e.g. When you receive PAL satellite signal with NTSC TV type setting or vice versa)*

7.3 System Parameters

9 Setting Aspect Ratio

This sub-menu allows you to select your TV aspect ratio to 4:3 or 16:9 according to your wishes.

- ① Press **MENU** key.
- ② Press  or  to select '**System Parameters**', and press .
- ③ Press  or  to select '**Aspect Ratio**'.
- ④ Press  or  to select '**4x3**' or '**16x9**'.







4x3	When your TV is 4:3.
16x9	When your TV is 16:9.

** Note : If you set 4 x 3 when the Satellite input signal is 16 x 9, the right and the left parts of the original picture may not be seen.*

7.3 System Parameters

10 Setting Screen

You can select the satellite input signal display mode.







- ① Press **MENU** key.
- ② Press  or  to select '**System Parameters**', and press .
- ③ Press  or  to select '**Screen**'.
- ④ Press  or  to select '**P/S**' or '**L. Box**'.

P/S	When you set screen display boundary from Pan/Scan data of Satellite input signal. (For signal for 16x9 program)
L.Box	You can watch 16 x 9 ratio screen by reducing original size vertically and horizontally.

- * Note : 1. If you select 'L.Box', the screen might be distorted. Upper and lower part of the screen will be blocked with black stripes.
2. 'Screen' function is helpful when receiving 16 x 9 signal with TV of 4x3 format.*

11 Setting Scart Video Output mode

You can set video output mode for 2 scart connectors on the rear panel for true video quality.

- ① Press **MENU** key.
- ② Press  or  to select '**System Parameters**', and press .
- ③ Press  or  to select '**A/V Mode**'.
- ④ Press  or  to select '**CVBS**', '**Y/C**', '**RGB**'.

CVBS	Video out signal from TV, AUX scart will be composite.
Y/C	Video out signal from TV, AUX scart will be Y, C.
RGB	Video out signal from TV scart will be output as RGB. Video out signal from AUX scart will be CVBS.



7.4 Transponder

1 TP Edit / Scan

After 'LNB Configuration' and 'Antenna Setup' procedure, when necessary, you can edit and/or add certain TPs (transponders)

- 1 Press **MENU** key.
- 2 Select '**Installation**' with **CH▲** or **CH▼**, and press **↓**.

Screen



- 3 Select '**TP Edit/Scan**' with **CH▲** or **CH▼**, and press **↓**.

Screen

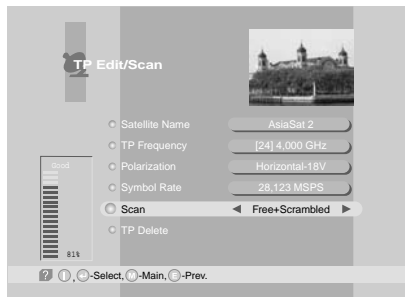

- 4 Select the '**Satellite Name**' which includes the **TP** you want to add/edit with **VOL▲** or **VOL▼**.
- 5 Move to '**TP Frequency**' with **CH▼** and select the **TP** you want to edit with **VOL▲** or **VOL▼**.
- 6 If you want to add the new TP, enter the TP frequency with numeric keys.



7.4 Transponder

- 7 Select 'Polarization' by pressing **CHV** and the set the proper value for selected TP with **VOL** or **VOL**.
- 8 Select 'Symbol rate' by pressing **CHV** and enter the symbol rate value for the selected TP with numeric keys.
- 9 After entering all values of the TP parameters, move to 'SCAN' section (column) with **CHV** and press **Enter** for storing all the entered TP data.
- 10 As a result, you can get the following menu showing the scanning process.

Screen

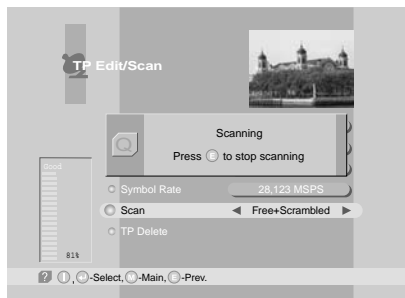

- 11 After scanning process, the first channel of scanned TP will be displayed.

Screen

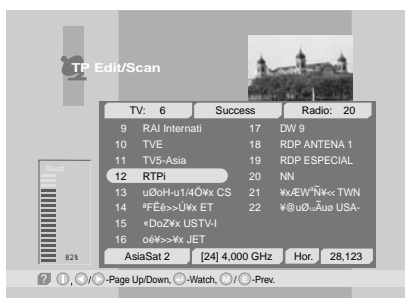

***Note :** If the scan fails, please check whether your entered values are correct or not and the signal reception sensitivity is good or bad.

7

7.4 Transponder

2 TP Delete

- ① Press **MENU** key.
- ② Select 'Installation' with **CH▲** or **CH▼**, and press **↓**.
- ③ Select 'TP Edit/Scan' with **CH▲** or **CH▼**, and press **↓**.

Screen

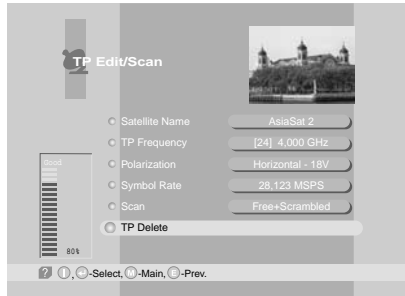

- ④ Move to **TP** section (column) with **CH▼** and select the **TP** you want to delete with **VOL◀** or **VOL▶**.
- ⑤ Move to '**TP Delete**' section (column) by pressing **CH▼** and press **↓**.
- ⑥ When the menu asks you to confirm the deletion, press **↓** if you want to delete it or press **EXIT** key if you want to void the deletion.

Screen

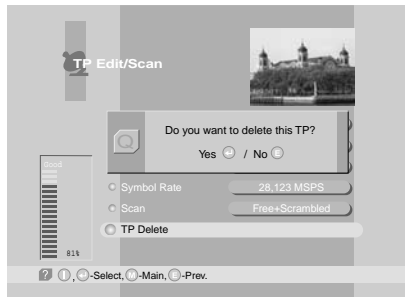

7

7.5 Factory Set

The status of the receiver will return to factory default parameters by using this function.

- 1 Press **MENU** key.
- 2 Select 'Installation' with **CH▲** or **CH▼**, and press **↵**.

Screen



- 3 Select 'Factory Set' with **CH▲** or **CH▼**, and press **↵**.

Screen

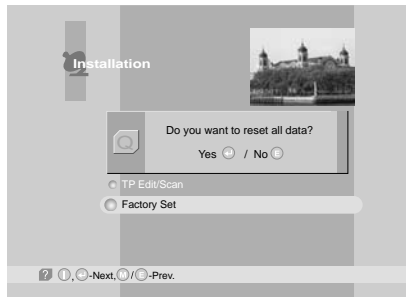

- 4 When the menu asks you to confirm the reset, press **↵** if you want to reset or press **EXIT** key if you want to void the reset.

7.6 Other Function on Remote Control

1 TV / SAT switching

This function is used for receiving a signal through the RF modulator. If your receiver has no 'TV ANT IN' terminal in the rear panel, this key may not work.

- ① Press 'TV/SAT'. The signal reception path will change to RF modulator and 'TV/SAT' LED on front panel will be lit.
- ② The signal output through the RF modulator will be as follows :

TV/SAT LED	Power ON	Power OFF
ON	TV ANT IN signal will be out.	
OFF	Decoded signal will be out through RF.	TV ANT IN signal will be out.

2 TV / RADIO switching

You can use this menu when you change a TV channel to a Radio channel or vice versa.

- ① Press 'TV/RADIO'.
- ② When listening a radio channel, 'r001' will be displayed on the front panel.

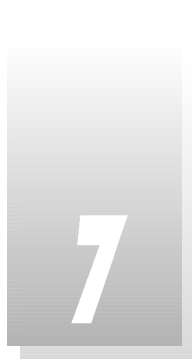

7.6 Other Function on Remote Control

3 GUIDE (EPG: Electronic Program Guide)

You can check the channel information on the channels of the transponder you are watching.

- ① Press **GUIDE** key, then the following menu will be displayed.

Screen

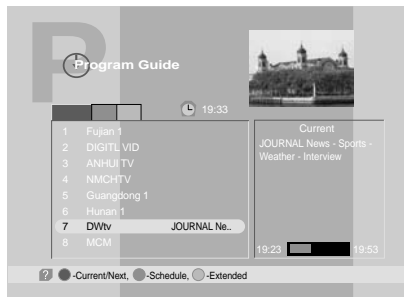

- * Note : 1. You can check local time, channel name, and other brief information on the current program.
- 2. If you didn't set local time under 'System Parameters' section, the GUIDE function may not work properly.
- 3. EPG information is delivered by satellite from service providers. If the channel does not carry any signal on the guide data, this function may not work properly.

- ② Select Channel with **CH+ / CH-**.

Then you can see current or next program information of the selected channel.

- ③ If you press **GREEN**, current or next program information would be converted to next or current program information respectively.

Screen



7

7.6 Other Function on Remote Control

- ④ If you press **YELLOW**, you can see program schedule list of the selected channel.

Screen

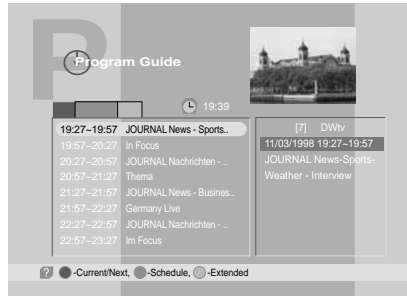

- ⑤ If you want to see program information of a program in the program schedule list, select the program with **CH▲** / **CH▼**. Then you can see the program information in the right window.

Screen

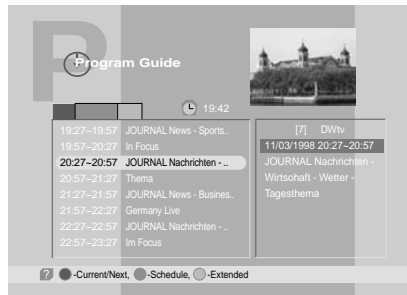

- ⑥ If you press **BLUE**, you can see extended program information of the selected program.

Screen

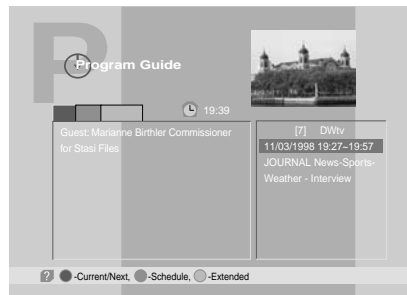

7

7.6 Other Function on Remote Control

- ⑦ You can set up automatic power on-off (Timer) or automatic recording on the program schedule list. After press **YELLOW** in the Guide(EPG) menu, select a program with **CH▲** / **CH▼** or **VOL▲** / **VOL▼** and press **ENTER**.
- ⑧ Select 'Once/Daily/Weekly/No' of 'Status' with **←** or **→**.
- ⑨ Select 'HD record' and set 'ON' with you want to record automatically.

Screen

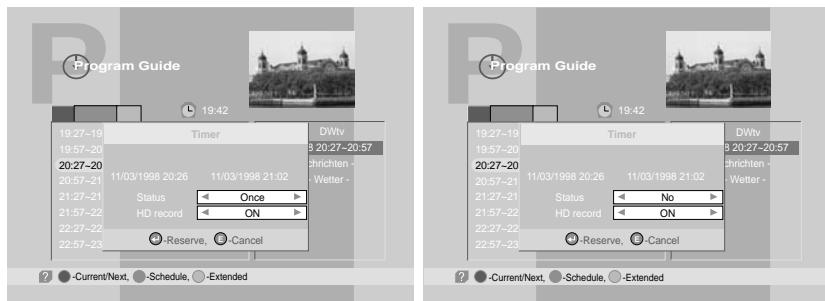

- ⑩ Press **ENTER** to save the new 'Timer' setting.

Screen

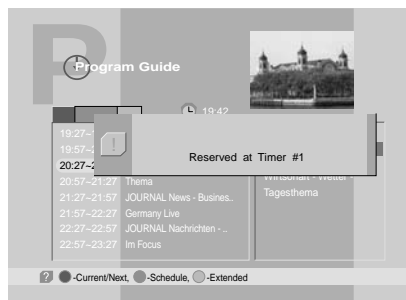

- ⑪ Press **MENU**, **EXIT** or **ENTER** to finish **GUIDE** menu.

- * Note : 1. Without 'STATUS' being actuated (Yes), 'Timer' does not work.
- 2. If a program of prior time than current time ('Local Time' in 'System Parameters' menu) is selected, Timer does not work.
- 3. Refer to 'Setting Timer' in 'System Parameters' in this manual.



7.6 Other Function on Remote Control

4 Subtitle/Audio

You can adjust the subtitle and audio condition/status of the current channel.

- 1 Press 'AUDIO' and subtitle and audio related window will be displayed on the screen.

Screen



- 2 In this example, program spoken language is 'English' and user's selected subtitle language is 'Swedish'.

Screen



The contents of each parameter are as follows ;

Subtitle Track	(Subtitle language #) of (all subtitle language available in this program)[Current selected subtitle language]
Audio Track	(Audio track #) of (all tracks available in this program) [spoken language in this program]
Audio Mode	Stereo -> Mono-Left -> Mono-Right
Dig.Output	Non-compressed / Compressed

*** Note :** These subtitle and audio parameters are workable only when the receiving channel supports these functions.

7.6 Other Function on Remote Control

5 Teletext

Teletext Service is text data service from Service Provider.
It is available only when the satellite signal carries teletext service data.

- 1 Press **BLUE** key and wait.

If '*' sign is pop up in the left upside of the screen as the following picture, wait until teletext service menu is displayed because '*' means 'This program provides teletext service. So wait a moment'.

Screen



- 2 Teletext Service Data is displayed as following picture.

Screen



- 3 Select your interesting item with numeric keys. For example, if you want to see about 'CITY GUIDE', press **6 0 0**.

Screen



7.6 Other Function on Remote Control

6 Sleep Timer

Your receiver will automatically power-off when the time you set is passed. Press '**SLEEP**' key until the right time you want appears.

Screen



- * Note : 1. You can set SLEEP TIMER in 30 minute steps up to 150 minutes.
- 2. The SLEEP TIMER does not work while you are in 'MENU', 'GUIDE' or 'CHANNEL LIST'.

7 Aux in

You can set in/out mode of the two scart connectors (TV, AUX) on the rear panel. Press '**Aux in**' key until the scart mode you want is displayed.

Screen



7

7.6 Other Function on Remote Control

Screen



Screen



SAT	Input satellite signal will be output to TV Scart and AUX (VCR) Scart. (can connect VCR to AUX connector for recording)
AUX	Input signal from AUX scart connector will be output to TV scart. If there is no input from AUX scart, your receiver will work as if you chose SAT mode.
AUX 2	Input signal from AUX scart connector will be output to TV scart by force.
TV	Input signal from TV scart connector will be output to AUX scart. (Only for CVBS)

*** Note :** You cannot see picture when set to AUX 2 mode and there is no input signal from outside.



7.6 Other Function on Remote Control

8 Channel / Information

Brief information is displayed, such as current channel type, name, local start/end time, guide information, current time, fav/normal mode, Audio mode and Audio ID.

- 1 Press **INFO**, then the information bar will pop-up.

Screen



- * *Note : If you have no information :*
 - *Check your local time setting is correct.*
 - *Information is not sent by the channel provider.*

Hard Disk Operation

8

8.1 Recording

1 Start Recording

You can record the current channel by pressing **RED(●)** key.
 If Program Guide menu has popped-up, you can record any channel you want.

- ① Press **RED(●)** key to record current channel.
- ② In Program Guide menu, press **RED(●)** key to record after selecting a program you want.

Then Record dialog menu will be displayed.

Screen

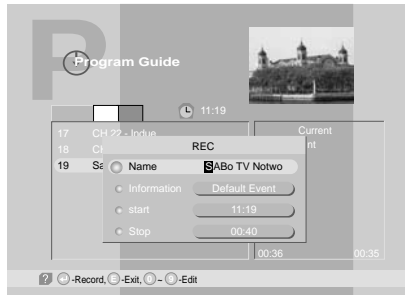

- ③ Some items can be edited in Record dialog menu.

** Note : Default recording duration time is setted for 2 hours or the duration time of scheduled program is setted for its scheduled time.*

- ④ Press **↓** to start recording.

Screen



8.1 Recording

- * Note : When a program is recorded, only the program stored in HD can be played and red R-icon is displayed.
Current recorded program is played automatically a little while later.

2 Stop Recording

To stop recording manually, you must enter HD-Program Guide menu and press **ORANGE(LIST)** key.

- ❶ If any program has been played, press **ORANGE(LIST)** key to enter HD-Program Guide menu.
- ❷ If HD-Program Guide menu is displayed.

Press **ORANGE(LIST)** key to stop recording.

Screen

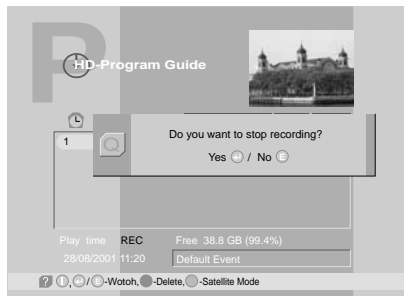

- * Note : If there are any user inputs in HD-Program Guide for 5-minutes without any playing and recording, your receiver will go automatically to power-off.

8.2 Playing

1 Start Playing

You must select a program to play stored programs.
For entering HD-Program Guide menu, press **ORANGE(LIST)** key.

- ① Press **ORANGE(LIST)** key.
- ② In HD-Program Guide, select a program by pressing **CH▲** or **CH▼**.

Screen



- ③ Press **▶** to start playing.

*** Note :** For controlling trick play mode, you must press **▶** or **INFO** key then **HD-Information Bar** will pop-up.

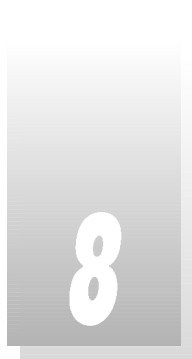

8.2 Playing

2 Trick Play Controls

For using trick play mode, you must press or **INFO** key then HD-Information Bar will pop-up.

Screen



Trick Play Mode : Pause, Jump, Fast Forward, Fast Reverse, Resume.

	HD Playing	HD Paused
YELLOW ►►	Fast Forward	Jump Forward
GREEN ◄◄	Fast Reverse	Jump Backward
BLUE ►	Pause	Resume
IVORY ■	Stop	Stop
INFO or	Info On/Off	Info On/Off

- Pause ① Press **BLUE** ►|| .
- Jump ① Press **BLUE** ►|| .
 ② Press **YELLOW** ►► or **GREEN** ◄◄ .
 ③ Press **BLUE** ►|| .
- Fast Forward ① Press **YELLOW** ►► .
- Fast Reverse ① Press **GREEN** ◄◄ .
- Stop ① Press **IVORY** ■ .

8.3 Delete Programs

You can delete any program in HD-Program Guide menu.

- ① Press **ORANGE(LIST)** key then HD-Program Guide menu will pop-up.
- ② In HD-Program Guide, select a program with **CH▲** or **CH▼**.
- ③ Press **RED(●)** key to delete the program then Delete dialog menu will pop-up.

Screen



- ④ Press **EXIT** key to delete the program or **EXIT** key to void.

*** Note :** For deleting any stored program, you must stop both playing and recording.

8.4 Lock Programs



If you want to lock any program, enter the advanced menu by pressing **MENU** key with HD- Information Bar.

After locking a program, you must enter the password for playing the program.

- ① Start playing a program.
- ② Press  then HD-Information Bar will pop-up.
- ③ Press **MENU** key, the advanced menu will pop-up.

Screen







- ④ Select 'LOCK' using  or .
- ⑤ Press , LOCK enable or disable will be setted with Yes or No.

*** Note :** *The password for playing a stored program is the same password for any other lock operation.*

8.5 Skip Play

You can set the part you don't want to play, such as advertisements. The skip part consists of start and end points. In all, 10 skip points are available.

- ① Select a program with  or , and press  to play in HD-Program Guide menu.
- ② Start playing and search the start point of skip play you want using trick play controls.
- ③ Press **RED** () key to set the start point.

Screen



- ④ Temporary start point will be displayed with a red pointer on the Bar.
- ⑤ Press **RED** () key to set the end point you want.

8.5 Skip Play

- 6 Then a proper pair of start and end points will be displayed with yellow pointers on the Bar.

Screen



* Note : To try setting on improper pair will be rejected.

- 7 Press **RED**(●) key at the position between start and end points, then the skip-point will be removed.
- 8 Press **MENU** key and select 'Clear skip points'.

Screen



- 9 Press **[Left Arrow]**, to remove all skip points.

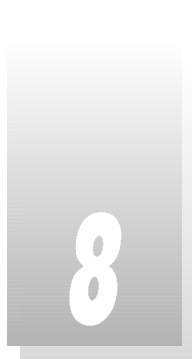

8.6 Split Operation

You can split a program in two programs.

The operation takes a few minutes to complete splitting.

- ① Select a program with **CH▲** or **CH▼**, and press **⏏** to play in HD-Program Guide menu.
- ② Search the split point you want using trick play controls.
- ③ Press **MENU** key, then the advanced menu will pop-up.

Screen



- ④ Select '**Split take**' menu and press **⏏**, then Split take dialog will pop-up.

Screen





8.6 Split Operation

- 5 Press to start splitting or **EXIT** key to void.
- 6 If split operation starts, the progress window will pop-up and you can see the status of process.

Screen

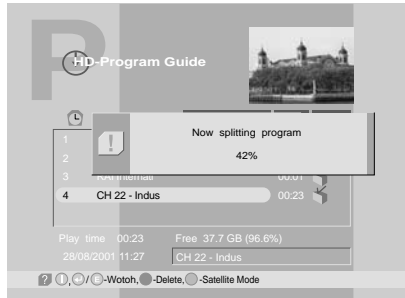

- 7 After splitting, HD-Program Guide menu will pop-up and splitted program will be selected.

Screen





8.7 Trick Play Controls without OSD

You can use trick play controls without HD-Information Bar.

Small yellow icon will be displayed for trick play controls.

Additional play control is available in this mode.

This function is activated at pause state using **GREEN(◀◀)** / **YELLOW(▶▶)**, and make the sequence played step by step.

- ① Select a program with  or , and press  to play in HD-Program Guide menu.
- ② Press **INFO** or  to turn off HD-Information Bar.
- ③ Press **BLUE(▶|)**, **GREEN(◀◀)** or **YELLOW(▶▶)** to start controlling trick play without any OSD.
- ④ You can control trick play while yellow icons are displayed.
- ⑤ Besides, you can control step by step play with **GREEN(◀◀)** / **YELLOW(▶▶)** while pause state.

*** Note : You can not control jump play without HD-Information Bar.**

Conditional Access

9

9.1 Insert CA Module(s) and Smart card(s)

To receive pay-TV channels you need a CA Module and a Smart card from the service provider (program distributor) of your preference. If you are subscribing to services from more than one service provider, you need to change different smart card or even different CA Modules.

Since a smart card is connected to a single service provider, a limited range of channels will be available. Without the CA Module and the smart card, you can watch only **'Free-to-Air'** programs.

* PIN-Code

The card is loaded with a 4-digit code, a so-called PIN code (Personal Identification Number). Normally the PIN code is '0000' or '1234'. The PIN code is necessary for the future extra service offered by the service provider.

9.2 Receiving Scrambled Channels

With a DVB COMMON INTERFACE compatible **CAM (Conditional Access Module)** and a **Smart card**, you can receive relevant scrambled channels and/or encrypted channels.

- ① Insert a **CAM** into one slot of your receiver.
(You can insert two **CAMs** at the same time)

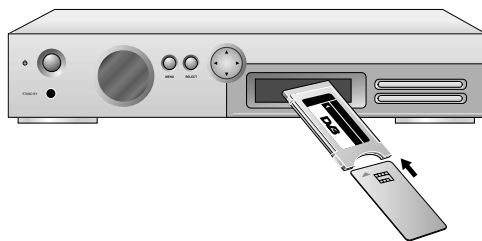

- * **Note** : 1. Insert the **CAM** fully into the slot so that the arrow marked on the **CAM** faces upwards and inwards.
2. Insert the smart card fully into the **CAM** so that the micro chip (gold color) faces upwards and inwards.

- ② The message of '**CAM Initializing**' will appear on the screen.
- ③ After the message '**CAM Initializing**' has disappeared, you can select the channel you want.

9.3 Information about CAM and Smart Card

You can check the status of **CAM** and smart card inserted in their slots.

- 1 Press **MENU** key.
- 2 Press **CHA** or **CHV**, and select the **Common Interface** you want, then press **Enter**.

Screen

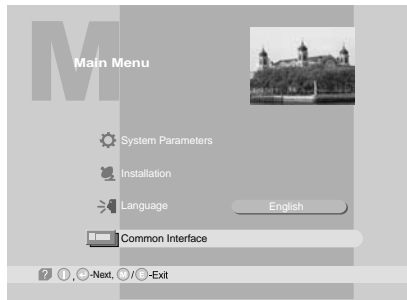

- 3 Brief information on selected **CAM** will be displayed.

Screen

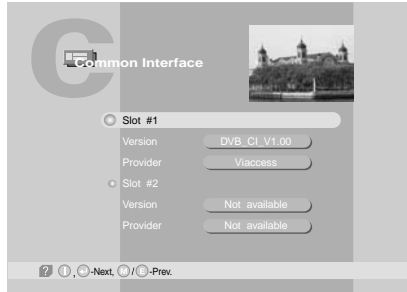

- 4 If you want detailed information on the selected **CAM** select slot number 1 or slot number 2 with **CHA** or **CHV** and press **Left Arrow**.
- 5 Proceed with further instructions displayed on the screen, depending on the **CAM** in use.

*** Note :** Further detailed information is not mentioned in this manual since the information depends on CAM and smart cards.

Trouble Shooting

10

There may be various reasons for the abnormal operation of the unit. Therefore, if the unit does not work properly, check it according to the procedures shown in the table below :

Problem	Possible causes	Remedy
LED on front panel does not light.	AC power cord disconnected.	Connect power cord properly into the power socket.
No Picture or sound.	Wrong connection of the video/audio output to TV input terminal. Wrong connection of satellite antenna cable. Wrong direction of satellite antenna. No signal or weak signal.	Connect two terminals correctly with scart cable or RCA or RF cable. Connect the antenna cable correctly. Adjust the direction of antenna. Check the cable connections, LNB and other equipment connected between the LNB and the receiver or adjust the antenna.
Black-and-white screen or V-Hold.	Wrong setting of channel information in MENU screen.	Type the setting value correctly.
Black-and-white screen or V-Hold.	Your TV mode is different from satellite broadcasting mode.	Use TV of same mode. Use the NTSC/PAL converter connected to the receiver and TV.
The remote controller is not working.	Battery exhausted. Fluorescent light interfering with the remote controller Remote controller is incorrectly aimed.	Change the batteries. Switch off the light. Aim the remote control at the receiver.

Specifications

11

System capabilities	Fully DVB compliant	
LNB/Tuner input	Connector	IEC 169-24, female
	Frequency range	950MHz ~ 2150MHz
	Signal level	-65dBm ~ -25dBm
	LNB supply	14/18V, max 400mA
	LNB switch control	22KHz
	DiSEqC	Ver 1.2 & Ver 1.0 Compatible
Demodulator	Front end	QPSK
	Symbol rate	4Msps ~ 45Msps
	SCPC and MCPC Capable	
	Spectral inversion	Auto conversion
System resource	Processor	32bit processor (50MHz)
	SDRAM	4Mbyte
	FLASH	2Mbyte
	EEPROM	2Kbyte
Video Decoder	MPEG 2	Main Profile @ Main Level
	Data Rate	up to 15M bits/s
	Resolution	720 X 576, 720 X 480
	Video format	NTSC, PAL
	Aspec Ratio	4:3, 16:9
Teletext	DVB compliant	
MPEG Audio	MPEG 1 layer 1 & 2	
	Type	Mono, Dual mono, Stereo, Joint Stereo
	Sampling rates	32, 44.1 and 48 KHz
Serial data interface	Connector	9pin D-sub male, Max 115K bps



Remote control	Code	NEC-IR
	Operating condition	up to 7 Meter
Power supply	Power consumption	max 40W
	Supply voltage	100V ~ 250V
	Supply frequency	47Hz ~ 63Hz
Rear Panel connectors	Video out	1 X RCA cinch
	Audio L/R	2 X RCA cinch
	DIGITAL OUT	1 X RCA cinch
	Serial data	9pin D-sub
	Digital tuner input	IEC 169 - 24
	Loop-through Digital tuner	IEC 169 - 24
	Terrestrial ant input (*)	IEC 169 - 2
	RF modulator output (*)	IEC 169 - 2
	TV SCART (European model only)	RGB, CVBS, Y/C, audio
	AUX SCART (European model only)	CVBS, Y/C, audio
RF modulator (PAL or NTSC) PAL G/I/K TV Type(*)	Connector	IEC 169-2, female/male
	Frequency	470 ~ 860MHz
	Output channel number	21 ~ 69
Physical Specification	Size (W X H X D)	335 X 58.5 X 268(mm)
	Weight (Net)	3.2kg

*** Note : These connectors can be removed by customer's requirement.**